



LP0172

**FITTING INSTRUCTIONS FOR LP0172BK LICENCE PLATE BRACKET**  
**YAMAHA R25 2014**

Page | 1



**THIS KIT CONTAINS THE ITEMS PICTURED AND LABELLED BELOW.**  
**DO NOT PROCEED UNTIL YOU ARE SURE ALL PARTS ARE PRESENT.**  
Please note that the way the kit is packed does not necessarily represent the way of mounting to the bike

THE PARTS SHOWN MAY BE REPRESENTATIVE ONLY (FOR CLARITY OF INSTRUCTIONS ONLY)

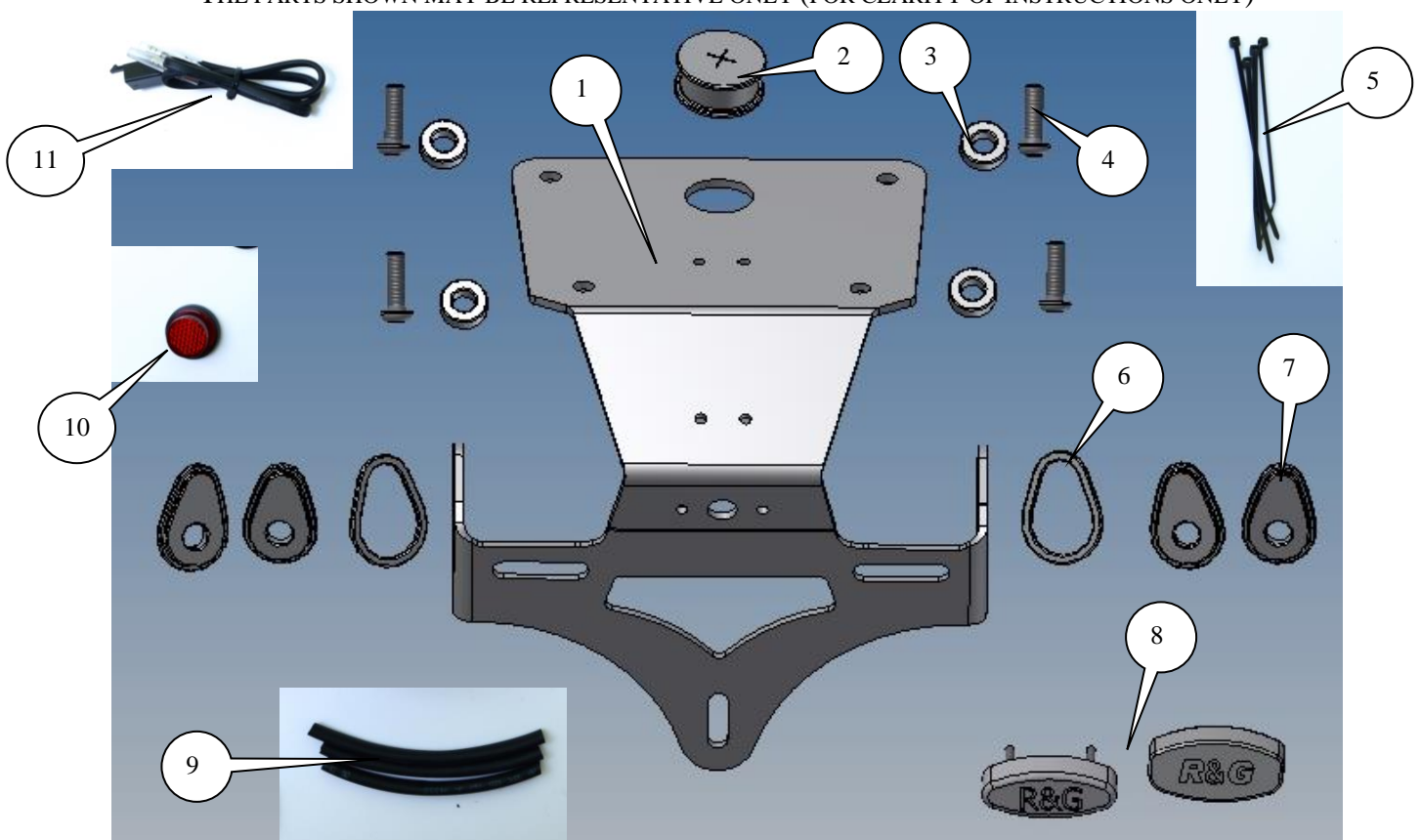

R&G Racing

Unit 1, Shelley's Lane, East Worldham, Alton, Hampshire, GU34 3AQ

Tel: +44 (0)1420 89007 Fax: +44 (0)1420 87301 [www.rg-racing.com](http://www.rg-racing.com) Email: [info@rg-racing.com](mailto:info@rg-racing.com)



LP0172

**LEGEND**

- ITEM 1 = LICENCE PLATE MOUNTING BRACKET (TB0172BK) (x1).
- ITEM 2 = RUBBER WIRING GROMMET (RB0002) (x1).
- ITEM 3 = MOUNTING SPACERS (S0299) (x4).
- ITEM 4 = M6x20mm BUTTON HEAD BOLTS (x4).
- ITEM 5 = SMALL CABLE TIES LONG (x4).
- ITEM 6 = ORIGINAL INDICATOR SPACERS (I0037) (x2).
- ITEM 7 = MINI INDICATOR ADAPTORS (I0016) (x4).
- ITEM 8 = LICENCE PLATE ILLUMINATOR ASSEMBLY (LA0002) (x1).
- ITEM 9 = 180mm LENGTHS OF HEAT SHRINK (x3).
- ITEM 10 = REFLECTOR (REFL 1) (x1).
- ITEM 11 = LICENCE PLATE ILLUMINATOR CONNECTOR (CON0007) (x1).
- ITEM 12 = SELF ADHESIVE CABLE CLIPS (x2).

Page | 2

Please note that in cases where kits are packed with rubber washers holding the components onto the bolt – *the rubber washers should be thrown away!*

**TOOLS REQUIRED**

- Set of metric Allen keys.
- Metric Socket set.
- Phillips driver.
- Small amount of super glue.

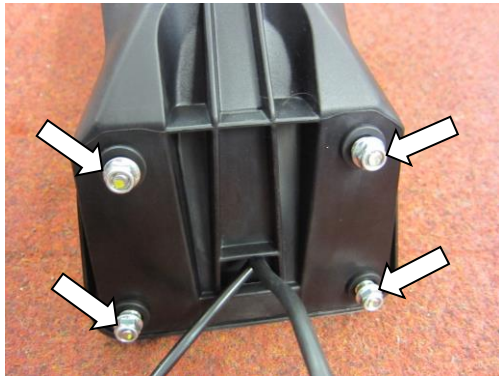

PICTURE 1

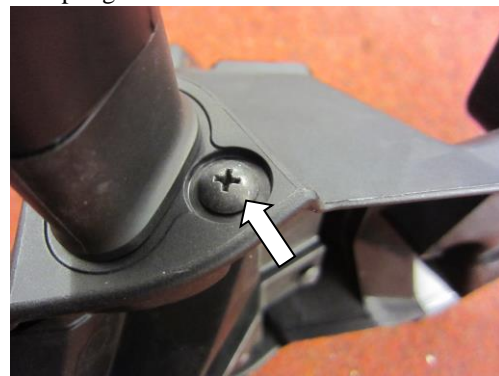

PICTURE 2



PICTURE 3

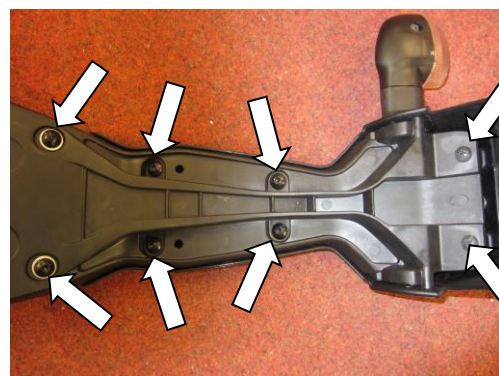

PICTURE 4



LP0172



PICTURE 5

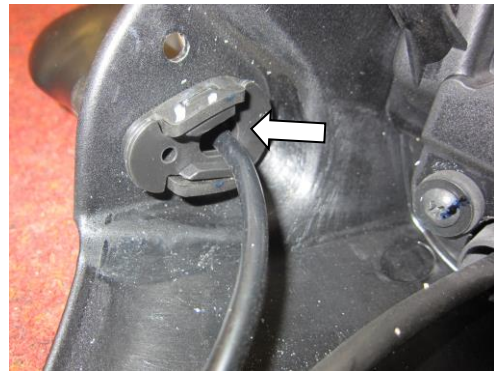

PICTURE 6

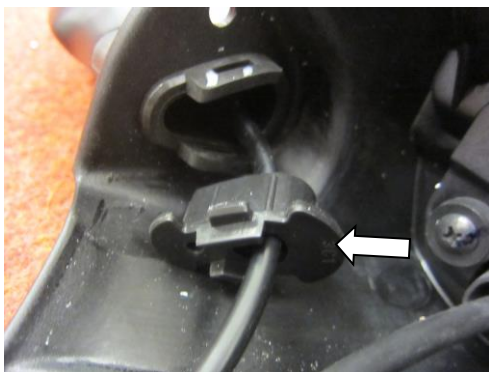

PICTURE 7



PICTURE 8



PICTURE 9

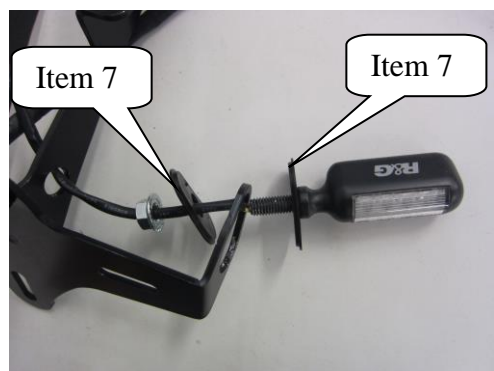

PICTURE 10



LP0172

Page | 4



PICTURE 11



PICTURE 12



PICTURE 13



PICTURE 14



PICTURE 15

### **FITTING INSTRUCTIONS**

- Remove the pillion seat using the key.
- Disconnect the indicator and licence plate illuminator wiring plug sockets.
- Remove the four nuts that hold the original licence plate bracket from under the pillion seat as arrowed in picture 1.
- With the original licence plate bracket removed, remove the two screws arrowed in pictures 2 and 3.
- Remove the four bolts and four screws arrowed in picture 4.

R&G Racing

Unit 1, Shelley's Lane, East Worldham, Alton, Hampshire, GU34 3AQ

Tel: +44 (0)1420 89007 Fax: +44 (0)1420 87301 [www.rg-racing.com](http://www.rg-racing.com) Email: [info@rg-racing.com](mailto:info@rg-racing.com)



LP0172

- Remove the cable cover/support for access to the original indicators and wiring as shown in picture 5.

If using the original indicators

- Remove the spreader/location plate arrowed in pictures 6 and 7.
- Gently squeeze the indicator stem and remove the indicator as shown in picture 8.
- Repeat for the other indicator.
- Fit the original indicators to the new licence plate bracket (item 1) using the indicator adaptors (item 6) (in position arrowed in picture 9 so it fits in the groove in the stem and between the indicator and the bracket) as shown in picture 9.

If fitting R&G mini indicators (R&G product code RG370=bulb, RG371=LED or RG372 = Aero LED

- If fitting the R&G Mini Indicators, use the indicator adaptors (item 7) as shown in picture 10 (use one adaptor either side of the bracket). Connect the R&G Mini Indicators to the wiring loom and check the operation at this stage (if illumination fails, swap the bullet connections around). (Please use the heat-shrink (item 9) to protect the new indicator wiring).
- Fit the new licence plate illuminator (item 8) to the licence plate bracket assembly as shown in picture 11 (please use the provided heat shrink (item 9) to protect the wiring).
- **PLEASE NOTE YOU WILL NEED TO GLUE THE LIGHT SHROUD TO THE LED LICENCE PLATE ILLUMINATOR USING SUPER GLUE.**
- Push the rubber wiring grommet (item 2) into the larger hole in the licence plate bracket as shown in picture 12.
- Push the wires through the centre of the wiring grommet as shown in pictures 12 and 13.
- Use the self-adhesive clips (item 12) and cable ties (item 5) to tidy and secure the wiring as shown in picture 13.
- Using a small amount of super glue stick the four mounting spacers (item 3) into position as shown in picture 14 (gluing these spacer into position makes the mounting easier).
- Offer the new assembly into position as original while feeding the wires through the under-tray as original and secure using the four button head bolts (item 4) from underneath and the four original nuts as shown in picture 15.
- Reconnect all the indicator wiring plug sockets and check operation (if illumination fails, swap the bullet connections around).
- Connect the licence plate illuminator using the supplied connector (item 11) (if illumination fails, swap the bullet connections around).
- Fit licence plate to new licence plate bracket (it may require re-drilling).
- **IMPORTANT: IF FITTING A FULL-SIZE LICENCE PLATE AND PLACING IT FAR DOWN ON THE LICENCE PLATE HANGER, THERE IS A SMALL CHANCE OF THE LICENCE PLATE HITTING THE BACK WHEEL UNDER HEAVY LOAD AND OVER LARGE BUMPS IN THE ROAD. IT IS YOUR RESPONSIBILITY TO CHECK FOR THIS POSSIBILITY AND TAKE AVOIDING ACTION. FAILURE TO CHECK THIS COULD RESULT IN SERIOUS INJURY.**
- Refit the seat.
- Depending on local laws, attach enclosed red reflector (item 10) in an appropriate location.
- **Please test the indicators, rear light and licence plate illuminator before riding.**

ISSUE 1 08/10/2014 (NSY)

R&G Racing

Unit 1, Shelley's Lane, East Worldham, Alton, Hampshire, GU34 3AQ

Tel: +44 (0)1420 89007 Fax: +44 (0)1420 87301 [www.rg-racing.com](http://www.rg-racing.com) Email: [info@rg-racing.com](mailto:info@rg-racing.com)



LP0172

**CONSUMER NOTICE**

The catalogue description and any exhibition of samples are only broad indications of the Products and R&G may make design changes which do not diminish their performance or visual appeal and supplying them in such state shall conform to the order. The Buyer acknowledges no representation or warranty (other than as to title) has been given or will apply to the Products other than those in R&G's order or confirmation and the Buyer confirms it has chosen the Products as being of merchantable quality and suitable for its particular purposes. Where R&G fits the Products or undertakes other services it shall exercise reasonable skill and care and rectify any fault free of charge unless the workmanship has been disturbed. The Buyer is responsible for ensuring that the warranty on the motorcycle is not affected by the fitting of the Products. On return of any defective Products R&G shall at its option either supply a replacement or refund the purchase money but shall not be liable if the Products have been modified or used or maintained otherwise than in accordance with R&G's or manufacturer's instructions and good engineering practice or if the defect arises from accident or neglect. Other than identified above and subject to R&G not limiting its liability for causing death and personal injury, it shall not be liable for indirect or consequential loss and otherwise its liability shall be limited to the amounts paid by the Buyer for the Products or the fitting or service concerned. These terms do not affect the Buyer's statutory rights.

Page | 6

**R&G RACING RETURNS POLICY (NON-FAULTY GOODS)**

Returns must be pre-authorized (if not pre-authorized the return will be rejected). Goods may only be returned direct to us if they were purchased direct from us (customer must prove if necessary). Otherwise to be returned to original vendor. Goods must be in re-sellable condition, in the opinion of R&G Racing. All returns are subject to a 25% restocking and handling fee (25% of the gross value exc. P&P – at the prevailing price at time of purchase). The customer must pay any and all carriage charges. No returns of discontinued products, unless within 14 days of purchase. This policy does not affect your statutory rights and does not refer to faulty goods.

R&G Racing

Unit 1, Shelley's Lane, East Worldham, Alton, Hampshire, GU34 3AQ

Tel: +44 (0)1420 89007 Fax: +44 (0)1420 87301 [www.rg-racing.com](http://www.rg-racing.com) Email: [info@rg-racing.com](mailto:info@rg-racing.com)



LP0172

**INSTRUCTIONS DE MONTAGE POUR LP0172BK SUPPORT DE PLAQUE**  
**YAMAHA R25 2014**

Page | 7



**Assurez vous que toutes les pièces soient présentes avant de procéder au montage.**

**La façon dont le kit est emballé ne correspond pas forcément à la façon de monter les pièces sur la moto.**

LES PIÈCES PRESENTÉES PEUVENT N'ÊTRE QUE REPRESENTATIVES, AFIN DE FACILITER ET CLARIFIER LES INSTRUCTIONS DE MONTAGE.

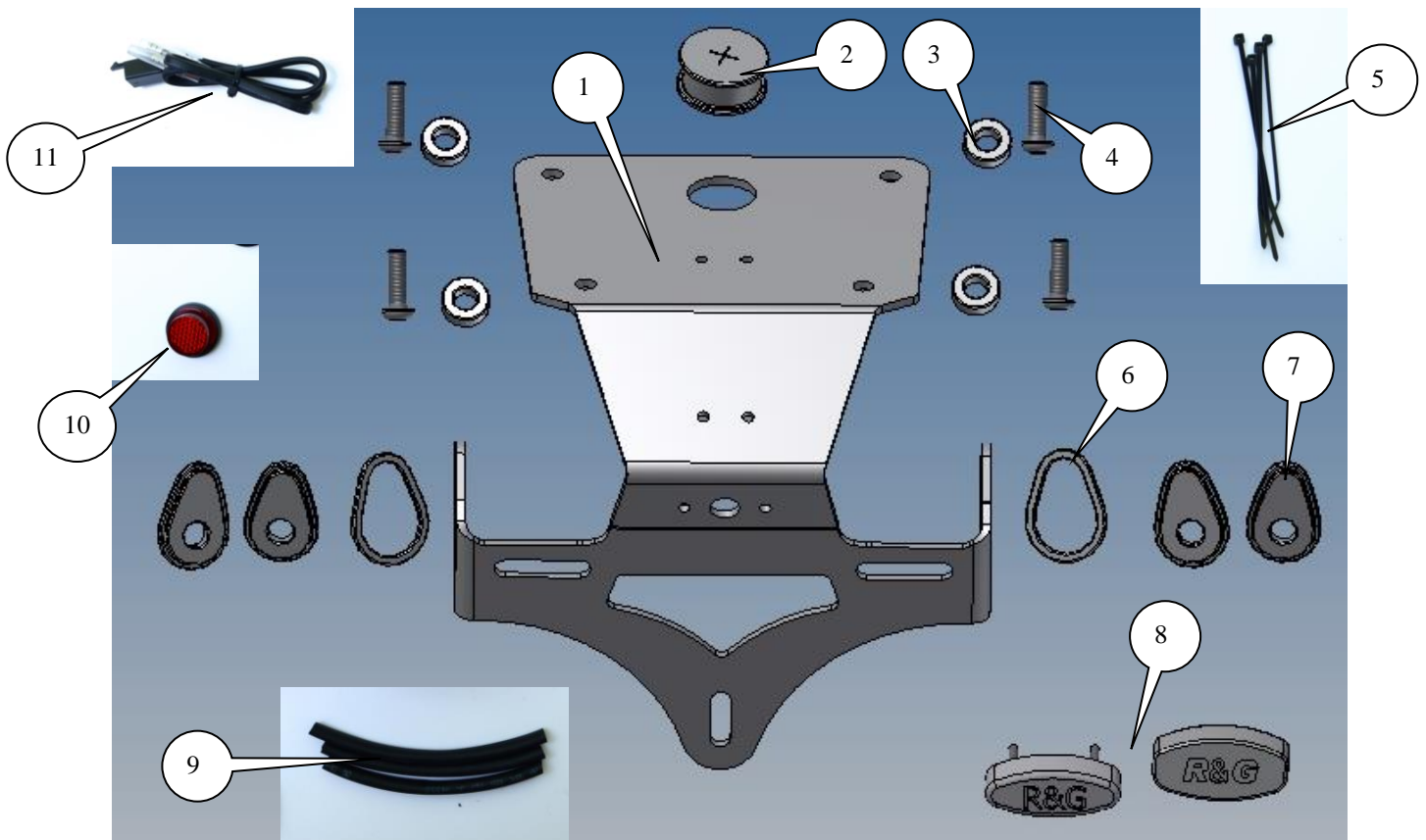

R&G Racing

Unit 1, Shelley's Lane, East Worldham, Alton, Hampshire, GU34 3AQ

Tel: +44 (0)1420 89007 Fax: +44 (0)1420 87301 [www.rg-racing.com](http://www.rg-racing.com) Email: [info@rg-racing.com](mailto:info@rg-racing.com)



LP0172

Page | 8

### **LEGENDE**

- ARTICLE 1 = SUPPORT DE PLAQUE (TB0172BK) (x1).  
ARTICLE 2 = ŒILLET DE CAOUTCHOUC (RB0002) (x1).  
ARTICLE 3 = ENTRETOISES (S0299) (x4).  
ARTICLE 4 = M6x20mm BOULONS (x4).  
ARTICLE 5 = PETITS COLLIERS DE SERRAGE (x4).  
ARTICLE 6 = ENTRETOISES INDICATEURS D'ORIGINE (I0037) (x2).  
ARTICLE 7 = ADAPTATEURS MINI CLIGNOTANTS (I0016) (x4).  
ARTICLE 8 = ASSEMBLAGE FEU DE PLAQUE (LA0002) (x1).  
ARTICLE 9 = 180mm BANDEAUX THERMO RETRACTABLES (x3).  
ARTICLE 10 = REFLECTEUR (REFL 1) (x1).  
ARTICLE 11 = CONNECTEUR FEU DE PLAQUE (CON0007) (x1).  
ARTICLE 12 = CLIPS AUTOCOLLANTS (x2).

Notez que si les kits sont emballés avec des rondelles en caoutchouc servant à tenir les composants, *ces rondelles doivent être jetées.*

### **OUTILS REQUIS**

- Jeu de clés Allen.
- Ensemble clé métrique.
- Tournevis cruciforme.
- Un peu de super glue.

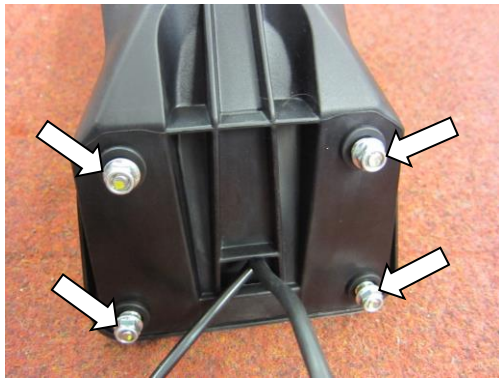

PHOTO 1

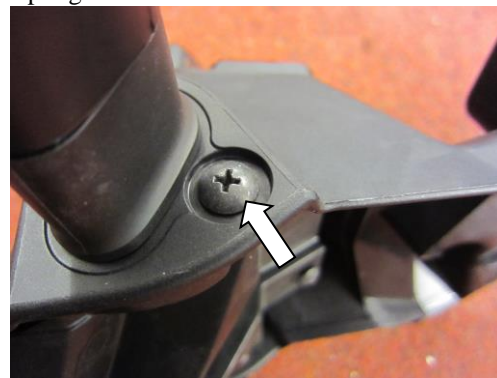
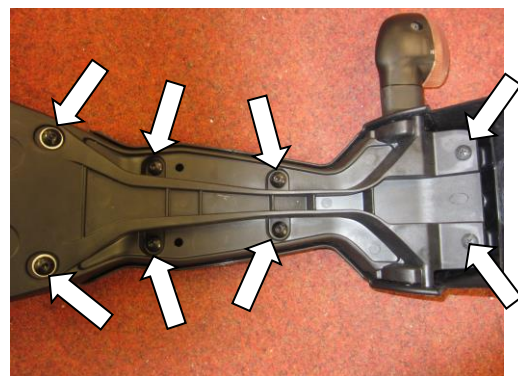
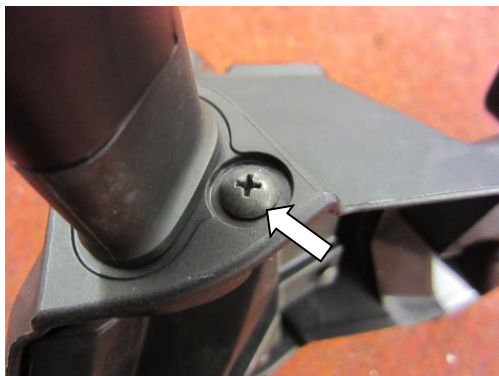

PHOTO 2



R&G Racing

Unit 1, Shelley's Lane, East Worldham, Alton, Hampshire, GU34 3AQ  
Tel: +44 (0)1420 89007 Fax: +44 (0)1420 87301 [www.rg-racing.com](http://www.rg-racing.com) Email: [info@rg-racing.com](mailto:info@rg-racing.com)





LP0172

PHOTO 3

PHOTO 4

Page | 9



PHOTO 5



PHOTO 6

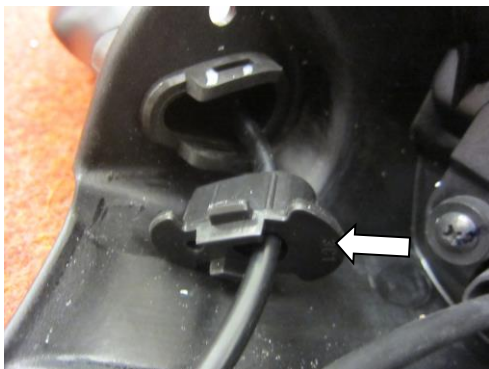

PHOTO 7



PHOTO 8



PHOTO 9

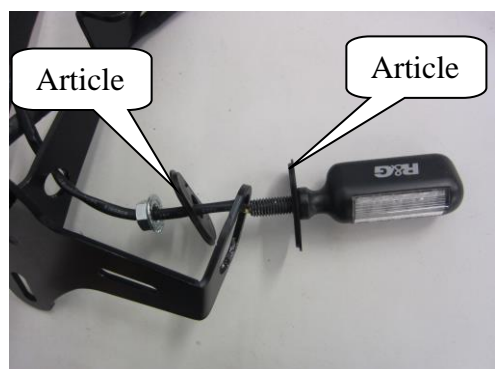

PHOTO 10



LP0172

Page | 10



PHOTO 11



PHOTO 12



PHOTO 13



PHOTO 14



PHOTO 15

**INSTRUCTIONS DE MONTAGE :**

- Enlever le siège passager à l'aide de la clé.
- Déconnecter le clignotant et la prise du feu de plaque.
- Enlever les 4 écrous qui fixent le support de plaque d'origine au dessous du siège passager, voir photo 1.
- Une fois le support de plaque enlevé, enlever les 2 vis indiquées sur les photos 2 et 3.
- Enlever les 4 boulons et les 4 vis indiqués sur la photo 4.

R&G Racing

Unit 1, Shelley's Lane, East Worldham, Alton, Hampshire, GU34 3AQ

Tel: +44 (0)1420 89007 Fax: +44 (0)1420 87301 [www.rg-racing.com](http://www.rg-racing.com) Email: [info@rg-racing.com](mailto:info@rg-racing.com)



LP0172

- Enlever le cache fil/support pour accéder aux clignotants d'origine et aux fils, voir photo 5.

Si vous utilisez les clignotants d'origine :

- Enlever l'épandeur/ la plaque de positionnement, voir photos 6 et 7.
- Appuyez doucement sur la tige du clignotant et enlever le clignotant, voir photo 8.
- Répétez pour l'autre clignotant.
- Monter les clignotants d'origine sur le nouveau support de plaque (article 1) en utilisant les adaptateurs de clignotant (article 6) (en position indiquée sur la photo 9 de façon à ce qu'ils se placent dans la rainure de la tige et entre le clignotant et le support ) voir photo 9.

Si vous montez les mini clignotants R&G (R&G code produit RG370=Ampoule, RG371=LED ou RG372 = LED latérale

- Si vous montez les mini clignotants, utilisez les adaptateurs de clignotants (article 7) comme sur la photo 10 (Utiliser un adaptateur de chaque coté du support). Connecter les minis clignotants R&G au linceul de feu et vérifier le bon fonctionnement des feux à ce stade du montage (Si l'éclairage échoue, tournez les connecteurs). (Utilisez de la gaine thermo rétractable (article 9) pour protéger les fils du nouveau clignotant).
- Montez les feux de plaque (article 8) sur l'assemblage support de plaque (photo 11) (Utilisez la gaine thermo rétractable fournie (article 9) pour protéger les fils).
- **VOUS DEVREZ COLLER LE LINCEUL DE FEU AU FEU DE PLAQUE LED A L'AIDE DE LA SUPERGLUE.**
- Pousser l'œillet de caoutchouc (article 2) dans le trou le plus large du support de plaque (photo 12).
- Pousser les fils au centre de l'œillet de caoutchouc (photos 12 et 13).
- Utilisez les clips autocollants (article 12) et les colliers de serrage (article 5) pour fixer les fils (photo 13).
- Utilisez un peu de superglue pour coller les 4 entretoises (article 3) en position (photo 14) (Coller ces entretoises rend le montage plus facile).
- Mettre le nouvel assemblage en position, tout en passant les fils à travers le passage de roue comme à l'origine puis fixer à l'aide de 4 boulons (article 4) à partir du passage de roue et des 4 écrous (photo 15).
- Reconnecter toutes les prises de clignotant puis vérifier que l'éclairage fonctionne (Si l'éclairage échoue, tournez les connecteurs).
- Connecter le feu de plaque à l'aide du connecteur fourni (article 11) (Si l'éclairage échoue, tournez les connecteurs).
- Remettre la plaque d'immatriculation (cela peut nécessiter un perçage).
- **IMPORTANT: Si vous installez une grosse plaque, il y a un risque que la plaque entre en contact avec la roue arrière en cas de choc sur la route (bosse, grosse charge etc...). Il est de votre responsabilité de vérifier que cela ne puisse pas se produire. Ne pas effectuer ces vérifications peut entraîner des dommages ainsi que des blessures graves pour le pilote.**
- Remettre le siège.
- Selon la loi locale, monter les réflecteurs (article 10) aux emplacements appropriés.
- Revérifiez que les clignotants et les feux de plaque fonctionnent bien avant de prendre la route.



LP0172

Page | 12

#### **CONSUMER NOTICE**

The catalogue description and any exhibition of samples are only broad indications of the Products and R&G may make design changes which do not diminish their performance or visual appeal and supplying them in such state shall conform to the order. The Buyer acknowledges no representation or warranty (other than as to title) has been given or will apply to the Products other than those in R&G's order or confirmation and the Buyer confirms it has chosen the Products as being of merchantable quality and suitable for its particular purposes. Where R&G fits the Products or undertakes other services it shall exercise reasonable skill and care and rectify any fault free of charge unless the workmanship has been disturbed. The Buyer is responsible for ensuring that the warranty on the motorcycle is not affected by the fitting of the Products. On return of any defective Products R&G shall at its option either supply a replacement or refund the purchase money but shall not be liable if the Products have been modified or used or maintained otherwise than in accordance with R&G's or manufacturer's instructions and good engineering practice or if the defect arises from accident or neglect. Other than identified above and subject to R&G not limiting its liability for causing death and personal injury, it shall not be liable for indirect or consequential loss and otherwise its liability shall be limited to the amounts paid by the Buyer for the Products or the fitting or service concerned. These terms do not affect the Buyer's statutory rights.

#### **R&G RACING RETURNS POLICY (NON-FAULTY GOODS)**

Returns must be pre-authorized (if not pre-authorized the return will be rejected). Goods may only be returned direct to us if they were purchased direct from us (customer must prove if necessary). Otherwise to be returned to original vendor. Goods must be in re-sellable condition, in the opinion of R&G Racing. All returns are subject to a 25% restocking and handling fee (25% of the gross value exc. P&P – at the prevailing price at time of purchase). The customer must pay any and all carriage charges. No returns of discontinued products, unless within 14 days of purchase. This policy does not affect your statutory rights and does not refer to faulty goods.

R&G Racing

Unit 1, Shelley's Lane, East Worldham, Alton, Hampshire, GU34 3AQ

Tel: +44 (0)1420 89007 Fax: +44 (0)1420 87301 [www.rg-racing.com](http://www.rg-racing.com) Email: [info@rg-racing.com](mailto:info@rg-racing.com)